

LANÇAMENTOS

Janeiro 2024

FREMAX

O MÁXIMO EM MOVIMENTO

BD7914

Disco de Freio Dianteiro | Ventilado | 332 x 32 mm

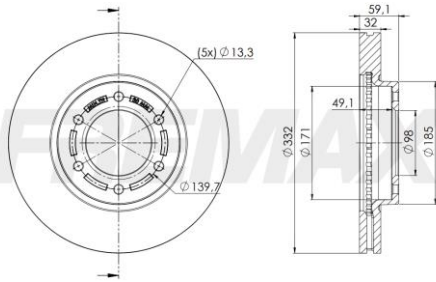

Marca	Veículo	Modelo	Ano Fab.	OE
-------	---------	--------	----------	----

Ford Ranger Raptor 2023 – EB3C1125BA – EB3Z1125A

Código	Preço (R\$)	Peso (kg)	Cód. Barras	Class. Fiscal	IPI	D x A (mm) Embalagem	Múltiplo de venda
BD7914	756,44	13,1	7893233079140	87083090	3,25	368x100	1

Obs. Preços em Reais (R\$) com ICMS base São Paulo (18%) sem IPI. Preços sujeitos a alterações, sem aviso prévio.

BD7915

Disco de Freio Traseiro | Ventilado | 332 x 24 mm

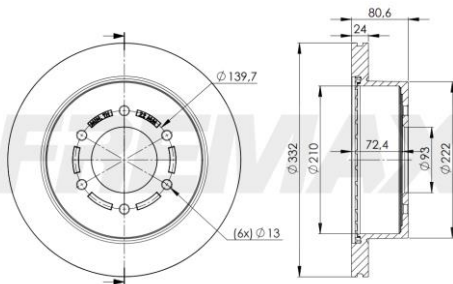

Marca	Veículo	Modelo	Ano Fab.	OE
-------	---------	--------	----------	----

Ford Ranger Raptor 2023 – JB3C2A315BA – JB3Z2C026A

Código	Preço (R\$)	Peso (kg)	Cód. Barras	Class. Fiscal	IPI	D x A (mm) Embalagem	Múltiplo de venda
BD7915	642,55	20,3	7893233079157	87083090	3,25	368x164	2

Obs. Preços em Reais (R\$) com ICMS base São Paulo (18%) sem IPI. Preços sujeitos a alterações, sem aviso prévio.

ACESSE O
CATÁLOGO:



WWW.AUTOEXPERTS.PARTS

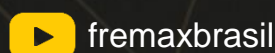

www.fremax.com

LANÇAMENTOS

Janeiro 2024

FREMAX

O MÁXIMO EM MOVIMENTO

BD2927

Disco de Freio Dianteiro | Ventilado | 354 x 32 mm

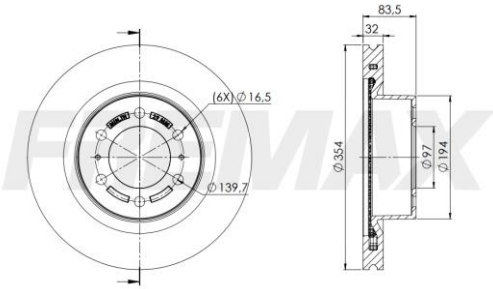

Marca	Veículo	Modelo	Ano Fab.	OE
-------	---------	--------	----------	----

Toyota Tundra 3.4 2022 – 435120C030 – 4351260290

Código	Preço (R\$)	Peso (kg)	Cód. Barras	Class. Fiscal	IPI	D x A (mm) Embalagem	Múltiplo de venda
BD2927	754,35	13,2	7893233029275	87083090	3,25	368x100	1

Obs. Preços em Reais (R\$) com ICMS base São Paulo (18%) sem IPI. Preços sujeitos a alterações, sem aviso prévio.

BD0214

Disco de Freio Traseiro | Ventilado | 335 x 20 mm

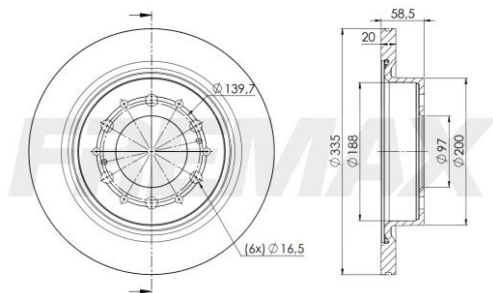

Marca	Veículo	Modelo	Ano Fab.	OE
-------	---------	--------	----------	----

Toyota Tundra 3.4 2022 – 424310C020

Código	Preço (R\$)	Peso (kg)	Cód. Barras	Class. Fiscal	IPI	D x A (mm) Embalagem	Múltiplo de venda
BD0214	621,422	16,2	7893233002148	87083090	3,25	368x121	2

Obs. Preços em Reais (R\$) com ICMS base São Paulo (18%) sem IPI. Preços sujeitos a alterações, sem aviso prévio.

Imagens meramente ilustrativas

ACESSE O
CATÁLOGO:



WWW.AUTOEXPERTS.PARTS

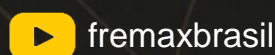

www.fremax.com

LANÇAMENTOS

Janeiro 2024

FREMAX

O MÁXIMO EM MOVIMENTO

BD5422

Disco de Freio Dianteiro | Ventilado | 330,5 x 28,5 mm

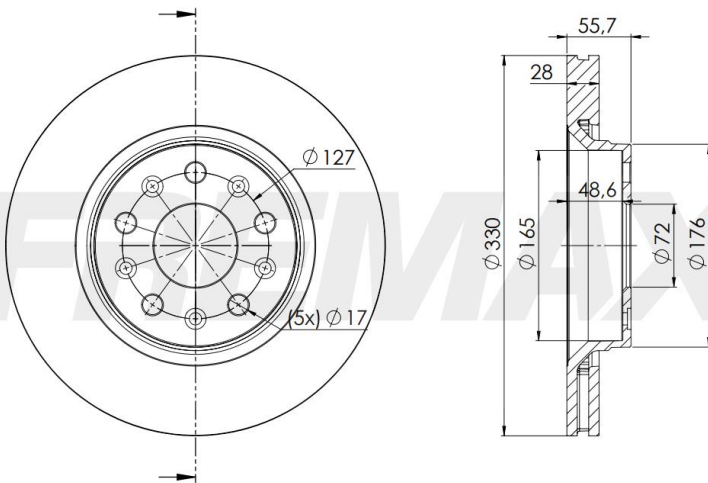

Imagens meramente ilustrativas

Marca	Veículo	Modelo	Ano Fab.	OE
JEEP	Wrangler	4x4	2018 –	68250085AA –
	Gladiator	3.0, 3.6	2021 –	68250085AB

Código	Preço (R\$)	Peso (kg)	Cód. Barras	Class. Fiscal	IPI	D x A (mm) Embalagem	Múltiplo de venda
BD5422	613,61	11	7893233054222	87083090	3,25	368x100	1

Obs. Preços em Reais (R\$) com ICMS base São Paulo (18%) sem IPI. Preços sujeitos a alterações, sem aviso prévio.

ACESSE O
CATÁLOGO:

WWW.AUTOEXPERTS.PARTS

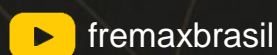

www.fremax.com